

Progeny Vantage Panoramic X-ray System



Installation Guide

For Vantage units manufactured during or after October 2012

Kit #60-A2050
REV. F

Part Number: 00-02-1608
ECN: P3031
REV. F

Contents

- Contents 2
- 1 Regulatory Information 3
 - Indications for Use 3
 - Contraindications 3
 - Warnings and Precautions 4
 - Compliance with Applicable Standards 6
 - Certified Components 7
 - Device Labeling 8
 - EC Declaration of Conformity 9
 - EMC Statement 10
 - Authorized Representatives 10
- 2 Introduction 11
 - Product Description 11
 - Disclaimer about the Manual 11
 - Symbols and Conventions 12
 - Obtaining Technical Support 13
- 3 System Overview 14
 - About the Vantage System 14
 - About the Panoramic X-ray Device 14
- 4 Pre-Installation Planning 18
 - Environmental Requirements 18
 - Support Requirements 19
 - Power and Cable Requirements 19
 - Space Requirements 20
 - Network and System Requirements 21
- 5 Installation 22
 - About Installation 22
 - Installing the Vantage Panoramic Device on a Wood Stud Wall 23
 - Installing the Vantage Panoramic Device on a Free Standing Base 32
 - Optional Right Entry Configuration 38
- 6 Installing the Cables 39
 - Connecting the Vantage to your network 39
 - Installing the Exposure Button 40
- 7 Starting Up 41
 - Turning the Vantage System On 41
 - Checking Image Quality 42
- 8 Vantage Software Client Setup 44
 - About 44
 - Installation Procedure 44
 - Connecting to Vantage 48
 - Progeny Support Information 50

1 Regulatory Information

In this Chapter

- Indications for Use
- Contraindications
- Warnings and Precautions
- Compliance with Applicable Standards
- Certified Components
- Device Labeling
- EC Declaration of Conformity
- EMC Statement
- Authorized Representatives

Indications for Use

Statement of Indications for Use

The intended use of the Progeny Vantage Panoramic Extraoral X-ray System is to provide dental radiographic examination and diagnosis of diseases of the teeth, jaw, and oral structures.

Guidelines for Patient Selection

The guidelines for use of the Progeny Vantage Panoramic Extraoral X-ray System are described in the “ADA/FDA Guide to Patient Selection for Dental Radiographs.” This device is to be operated only for the intended use as indicated by prescription of a qualified dental practitioner.

Contraindications

None known at this time.

Warnings and Precautions

Radiation Safety

Only qualified and authorized personnel may operate this equipment observing all laws and regulations concerning radiation protection.

- The operator during X-ray production must remain 2 m (6 ft.) from the focal spot and the X-ray beam for protection.
- Full use must be made of all radiation safety features on the equipment.
- Full use must be made of all radiation protection devices, accessories, and procedures available to protect the patient and operator from X-ray radiation.

Electrical Safety

- Only qualified and authorized service personnel should remove covers on the equipment.
- This equipment must only be used in rooms or areas that comply with all applicable laws and recommendations concerning electrical safety in rooms used for medical purposes, e.g., IEC, US National Electrical Code, or VDE standards concerning provisions of an additional protective earth (ground) terminal for power supply connection.
- Before cleaning or disinfecting, this equipment must always be turned off.
- The Progeny Vantage X-ray System is ordinary medical equipment without protection against ingress of liquids. To protect against short-circuit and corrosion, no water or any other liquid should be allowed to leak inside the equipment.

Explosion Safety

This equipment must not be used in the presence of flammable or potentially explosive gases or vapors, which could ignite, causing personal injury and/or damage to the equipment. If flammable disinfectants are used, the vapor must be allowed to disperse before using the equipment.

Cleanliness

To prevent cross contamination, always clean the patient contact areas and always install a fresh protective sheath over the bite guide before positioning a patient. The sheath recommended for this application is the TIDI Products, part number 21008.

Laser Safety

Do not stare into the beam. Do not place eyes closer than 100 mm. This equipment contains class 2 lasers of 3 mW output at 650 nm. The beam is a 40° fan line. The lensing on the laser is not removable. Laser on time does not exceed 100 seconds.

CAUTION! Use of procedures other than those contained within this manual may result in exposure to damaging laser light.

OBSOLETE

Compliance with Applicable Standards

Radiation Protection

The certified components of the Progeny Vantage Panoramic Dental X-ray System comply with Radiation Performance Standards 21 CFR, Subchapter J, at the time of manufacture.

Performance Standards

Standard	Content
IEC 60825-1:2001	Safety of Laser Equipment
IEC 60601-1	Medical electrical equipment - Part 1: General requirements for basic safety and essential performance
IEC 60601-1-1	Medical electrical equipment - Part 1-1: General requirements for safety - Collateral standard: Safety requirements for medical electrical systems
IEC 60601-2-7	Medical electrical equipment - Part 2-7: Particular requirements for the safety of high-voltage generators of diagnostic X-ray generators
IEC 60601-2-28	Medical electrical equipment - Part 2-28: Particular requirements for the safety of X-ray source assemblies and X-ray tube assemblies for medical diagnosis
IEC 60601-1-3	Medical electrical equipment – Part 1-3: General requirements for radiation protection in diagnostic X-ray equipment
IEC 60601-1-2	EMI/RFI
CAN/CSA 22.2 No. 601.1-M90	Canadian standard for medical electrical equipment
IEC 60601-2-32: 1994	Medical electrical equipment - Part 2-32: Particular requirements for the safety of associated equipment of X-ray equipment

Certified Components

Component	Reference Number
Pan tubehead assembly	60-A1014
Pan collimator assembly	60-A2009
Pan X-ray control assembly	60-A2035

OBSOLETE

Device Labeling

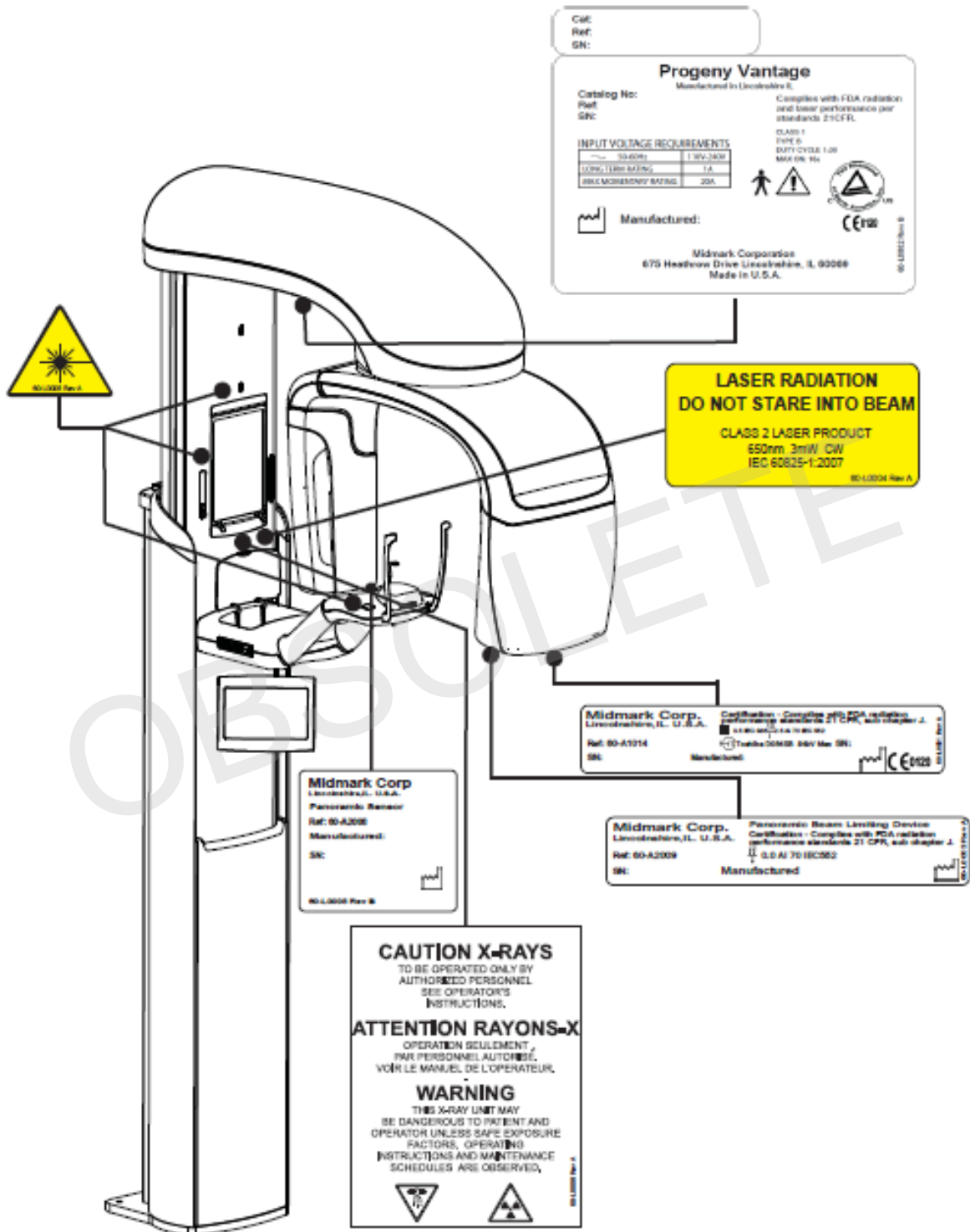

EC Declaration of Conformity

Name and Description of Product	Progeny Vantage Panoramic Dental X-ray System
	Catalog V5000 US Domestic Market Model 60-A0001 system
	Catalog V5100 Export Market Model 60-A0001 system
	Class: IIb
Reference Numbers to which Conformity is Declared	The following regulatory documents apply: UL 2601-1 IEC 60601-1-2 IEC 60601-1-3 IEC 60601-2-7 IEC 60601-2-28 IEC 60601-2-32 IEC 60825-1 Medical Device Directive ISO 13485
Declaration	Midmark Corporation declares that the products described herein meet all the applicable Essential Requirements of the EC Medical Device Directive 93/42/EEC in Annex I. For Class IIb products described herein, the product is manufactured, inspected, tested, and released in accordance with the approved quality assurance system established in accordance with ISO 13485 and Annex II of the EC Medical Device Directive under the Supervision of the SGS United Kingdom Ltd., a Notified Body.
Contact	Technical Support Midmark Corporation Phone: 888-924-3800 (Press 2) (U.S. and Canada) +1 847-415-9800 (Press 2) (International) Fax: 847-415-9810 techsupport@progenydenal.com Hours: 8:00 a.m. – 5:00 p.m. CT

EMC Statement

Information Regarding Potential EMC Interference And Advice For Avoidance

- Magnetic and Electrical fields are capable of interfering with the proper performance of this device. For this reason, make sure that all external devices operated in the vicinity comply with the relevant EMC requirements.
- Mains power quality should be that of a typical commercial or hospital environment.
- Power frequency magnetic fields should be at levels characteristic of a typical location in a commercial or hospital environment.
- If the above criteria cannot be verified, precautions shall be taken when using this equipment as the device may inadvertently operate.

Authorized Representatives

North America

MIDMARK CORPORATION
675 Heathrow Dr.
Lincolnshire, Illinois 60069 U.S.A.
Phone: 888-924-3800 (Press 3) (U.S. and Canada)
+1 847-415-9800 (Press 3) (International)
Fax: 847-415-9810

Europe

CE Partner 4U
Esdoornlaah 13
3951DB Maarn
The Netherlands
Phone: +31.343.442.524
Fax: +31.343.442.162

2 Introduction

In this Chapter

- Product Description
- Disclaimer about the Manual
- Symbols and Conventions
- Obtaining Technical Support

Product Description

The Progeny Vantage Panoramic X-ray System is an easy to use and easy to install digital panoramic X-ray system.









The panoramic X-ray provides a broad overview of the teeth, jaw, and oral structure of the entire mouth. The X-ray image supplies information about the teeth, upper and lower jawbone, sinuses, and other hard and soft tissues of the head and neck. The panoramic digital receptor is contained in a C-arm that moves around the patient's head.

The Vantage System has many applications that include evaluation of third molars, evaluation of patients with past and present TMJ (temporomandibular joint) problems, patients who require full or partial removable dentures, dental implants, or braces, those who are at risk or suspected of having oral cancer or other tumors of the jaw, those who have impacted teeth, and those who have had any recent trauma to the face or teeth (i.e., can help identify a fractured jaw).

Disclaimer about the Manual

Midmark pursues a policy of continual product development. Although every effort is made to produce up-to-date product documentation, this publication should not be regarded as an infallible guide to current specifications. We reserve the right to make changes without prior notice. The original language of this manual is English.

Symbols and Conventions

Symbol	Explanation
	Type B: Protection against electric shock (IEC 60601.1-1988).
	Consult written instructions in the User Guide.
	ATTENTION RAYONS-X: OPERATION SEULEMENT PAR DU PERSONNEL AUTORISE. VOIR MANUEL DE L'OPERATEUR.
	WARNING X-RAY THIS X-RAY UNIT MAY BE DANGEROUS TO PATIENT AND OPERATOR UNLESS SAFE EXPOSURE FACTORS AND OPERATING INSTRUCTIONS ARE OBSERVED.
	X-RAY EMISSION
L	Mains HOT WIRE
N	Mains NEUTRAL WIRE
	Earth Ground
	LASER RADIATION DO NOT STARE INTO BEAM CLASS 2 LASER PRODUCT. 650 nm, 3 mW
	Power off (circle) Power on (line)

Obtaining Technical Support

For Technical Support, contact:

MIDMARK CORPORATION
675 Heathrow Drive
Lincolnshire, Illinois 60069 U.S.A.
Phone: 888-924-3800 (Press 3) (U.S. and Canada)
+1 847-415-9800 (Press 3) (International)
Fax: 847-415-9810
techsupport@progeny dental.com

Hours: 8:00 a.m. – 5:00 p.m. CT

OBSOLETE

3 System Overview

In this Chapter

- About the Vantage System
- About the Panoramic X-ray Device

About the Vantage System

The Progeny Vantage Panoramic X-ray System consists of the panoramic X-ray device, the exposure button, and a Touch Control Panel.

About the Panoramic X-ray Device

The panoramic X-ray device consists of the telescoping column, the overhead assembly, the patient positioning table, and the touch control panel.

Telescoping Column

The telescoping column has two main parts: the fixed section and the moving or telescoping section. The fixed section contains the actuator to control up and down movement of the panoramic X-ray device. The telescoping section mounts the patient positioning features. Optical sensors in the telescoping section define the maximum and minimum extension of the column.

Overhead Assembly

The overhead assembly consists of an overhead arm and C-arm. The overhead arm supports the C-arm, which rotates. The C-arm includes the tubehead and the removable sensor. The tubehead produces the X-ray beam, and the sensor is a digital image receptor.

Patient Positioning Table

The patient positioning table guides and supports the patient's head during acquisition of panoramic X-ray images by means of the chin rest, bite guide, and positioning wands. The positioning control on the side of the patient positioning table has 4 buttons for the operator to control the up/down movement of the telescoping column, to apply and release the positioning wands, and to turn on positioning lights. The patient positioning table also contains a storage compartment.

Touch Control Panel

The touch control panel is mounted on the fixed column section under the patient positioning table. It is the main user interface for taking X-ray images with the Vantage System and is activated by touch.

Exposure Button

The exposure button is used by the operator to take the X-ray. The basic configuration consists of an exposure button connected to the panoramic X-ray device by a coil cord.

Bite Guide

A bite guide helps the patient keep his or her jaw correctly positioned. Additional bite guides may be obtained from Progeny. Always install a fresh protective sheath over the bite guide before positioning a patient. The sheath for this application is the Progeny part number 60-S0027.

Chin Rest

An easily removable chin rest fits into an opening on the patient positioning table. Additional chin rests may be obtained from Progeny.

TMJ Positioner

A TMJ positioner for TMJ X-rays fits into the patient positioning table. TMJ positioners are included with the Vantage.

Emergency Stop Switch

The stop switch, mounted under the left side of the patient positioning table near the telescoping column, is for use by the patient. Depressing the button will immediately halt all motor movement. Touching the control panel surface will also abort any movement. The button can be released by turning the knob.

Vantage System Panoramic X-ray Device

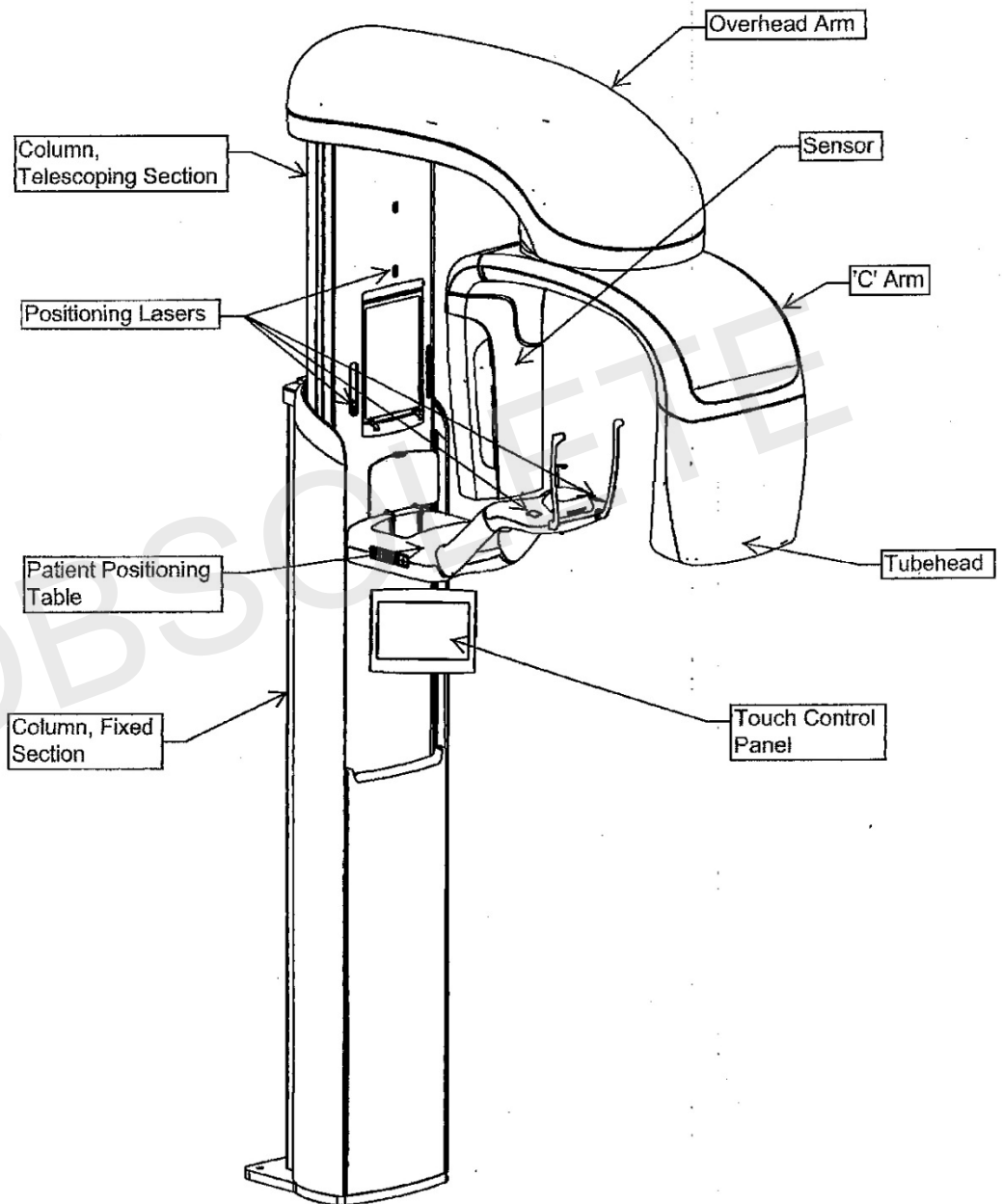

Vantage System Patient Positioning Table

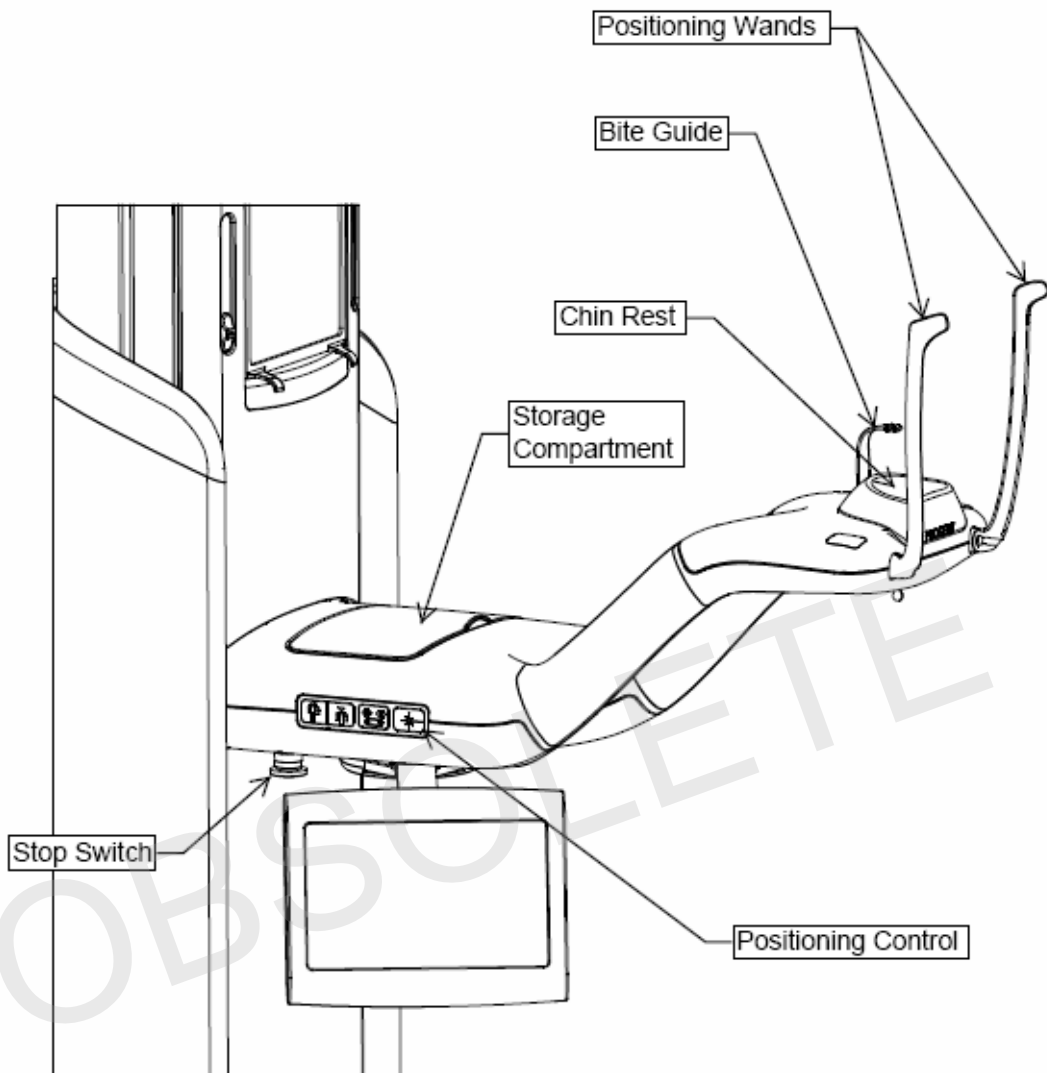

4 Pre-Installation Planning

In this Chapter

- Environmental Requirements
- Support Requirements
- Power and Cable Requirements
- Space Requirements
- Network and System Requirements

Environmental Requirements

Temperature

The Vantage panoramic device is intended for indoor use for normal dental applications at temperatures in the range +10 C to +35 C (+50 F to +95 F).

Storage temperature range should not exceed -35 C to +66 C (-31 F to +150 F).

Humidity

Humidity should not cause condensation to form on the device. When the device is being operated, humidity should not exceed 95% RH non-condensing. When the device is being stored, humidity should not exceed 90% RH non-condensing.

Support Requirements

About Support

The Vantage panoramic device is wall mounted. As an alternative, the Vantage panoramic device can be installed as a free standing unit. If the free standing installation method is used, the free standing base kit must be attached to the unit for support.

Wall Mounted Installation

Wall fasteners for the Vantage panoramic device must be able to withstand a 68 kg (150 lb.) shear force and a 180 kg (400 lb.) tensile (pull-out) load. The floor must be able to support approximately 90 kg (200 lb./sq. ft.) for wall mounted installation.

Free Standing Installation

The floor must be able to support approximately 158 kg (100 lb./sq. ft.) for free standing installation.

Power and Cable Requirements

Electrical Outlet Requirements

The Vantage System requires a dedicated, 15 amp minimum circuit. If a fixed connection is used, the length of the whip must conform to local codes. If a standard mains receptacle is used, it must be placed within 2 m (6 ft.) of the device and positioned in compliance with local codes.

Ethernet Connections

Cat 5e grade communications cable is required for connection of the Vantage panoramic system.

Optional Remote Exposure Switch

If a remote exposure switch is used, a four conductor cable capable of RJ 11 termination is required for installation.

Space Requirements

The fully extended column has a maximum height of 236 cm (93 in.) and depth of 121 cm (48 in.). The rotational reach of the overhead arm and C-arm is 108 cm (45 in.). See the diagram below.

The Vantage panoramic device has an optional right or left entry. The default configuration is left entry. *To configure a right entry, see Optional Right Entry Configuration in Chapter 6.*

Space Requirements

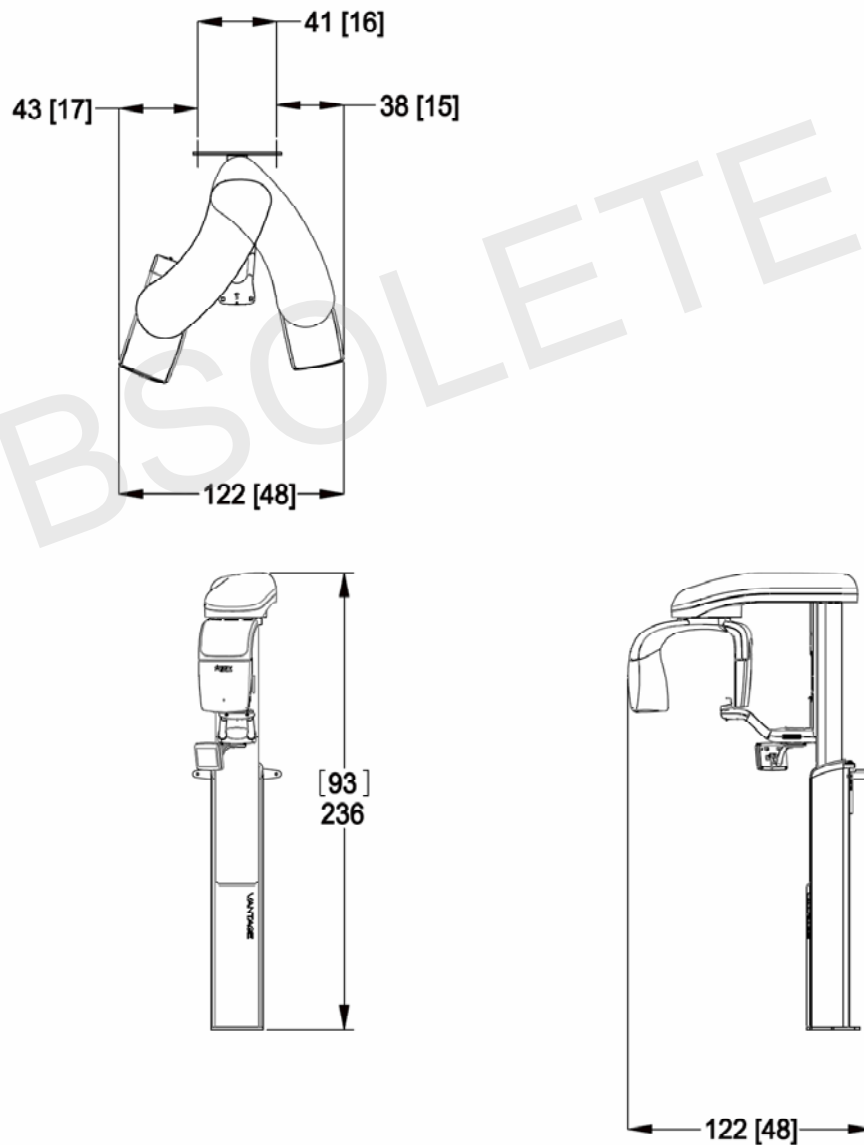

Network and System Requirements

The Vantage Software Client requires a computer for it to be installed on and a network connection to communicate with the Vantage Panoramic.

Network Requirements:

- An Ethernet based network connection at 100MBps or higher
- A wireless network connection at 802.11n or higher***

****A wireless network connection may introduce speed limitations that can result in a less than desirable image transmission time*

System Requirements:

Component	Requirement
Computer Hardware	PC - compatible Pentium 4 / 1.4 GHz or greater computer
Memory System	2 GB RAM or higher recommended (minimum 1 GB)
Operating System	Microsoft Windows XP Professional with Service Pack 3; Microsoft Vista (Business or Ultimate editions); Microsoft Windows 7 (Professional or Ultimate editions)
Disk Space	450 MB minimum NOTE: Additional disk space is needed depending on the size of the practice, the number of images, and other information you plan to store. Each image is approximately 4 MB. For example, approximately 300 GB are needed to store 75 000 images.
Display Settings	1024 x 768 (16 - bit or higher) with 32 MB (or higher) of Video RAM NOTE: It is possible to increase these settings based on the actual video adapter installed. As a rule, the better your video adapter or capture card the better your images.

5 Installation

In this Chapter

- About Installation
- Installing the Vantage Panoramic Device on a Wood Stud Wall
- Installing the Vantage Panoramic Device on a Free Standing Base
- Optional Right Entry Configuration

About Installation

The Vantage System panoramic device is preassembled and can be installed in a few easy steps. It has been designed to be installed by one person with an assistant in one hour, assuming that all pre-installation requirements have been met. Checking the image alignments can take an additional hour.

Check Pre-installation Requirements

Prior to beginning the installation, be sure that all pre-installation requirements have been completed. This includes confirming that the wall and floor support requirements are adequate for mounting the Vantage panoramic device, that the electrical requirements are met, and that wire locations are proper.

Optional Right Entry Configuration

The Vantage System is packaged with a left entry but can be configured with a right entry. *To configure a right entry, see Optional Right Entry Configuration in this chapter.*

Installing the Vantage Panoramic Device on a Wood Stud Wall

Preparing to Install the Vantage Panoramic Device

Gather Tools

- Level
- 2 mm hex key
- 4 mm hex key
- 6.3 mm (1/4 in.) pilot hole drill
- 9.5 mm (3/8 in.) pilot hole drill (masonry bit for cement floor)
- 14 mm (9/16 in.) socket wrench (for cement or wood floor)

Unpack the Hardware Kit

- Hardware for wall (wood mount): 1 wall bracket, 2 lag bolts, and 2 washers
- Hardware for cement floor: 2 cement anchors, 2 nuts, and 2 washers
- Hardware for wood floor: 2 lag bolts and two washers
- Hardware for attaching wall bracket to column: 2 clamps and 2 screws

Unpack the Removable Parts Kit

- Chin rest
- 2 wands
- Bite guide

Cautions

When using lag screws as the method of attachment, it is imperative to consider the full scope of the task. Several factors must be considered for safe, permanent installations. Some of the key issues are below:

- Lumber commonly used in construction projects can be different from location to location.
- The grade, age, position, and overall condition of wood can vary greatly.
- The attachment stud may have additional, hidden loads.
- The location of the pilot hole with respect to the center of the stud will affect the load bearing ability.
- The size of the pilot hole required for the lag screw will be different based on the grade, age, and condition of the lumber.
- Never over-tighten the lag screw as this will weaken the mechanical connection (18 ft.-lb. maximum).
- Lumber with splits or cracks should not be used for attachment.
- **Plywood, particle board, or similar construction materials should not be used for attachment.**
- Progeny provides fasteners for average installations. Based on specific installation conditions, it may be necessary to choose an alternate fastener or fastening methods.
- Seek the advice of a professional structural engineer to clarify any issues before the installation.

About the Order of Installation

For convenience and access, Progeny recommends the following order of installation described in the following sections:

- Remove the shipping brackets
- Attach the power
- Attach the bracket to the wall
- Snap the Vantage panoramic device in place
- Plumb the Vantage panoramic device and attach the clamps
- Mount the Vantage panoramic device to the floor

Remove the Shipping Brackets

Before attaching power, you need to remove the shipping brackets.

1. Remove the overhead top cover and remove the three orange shipping bolts from the overhead pivot area.

Overhead Top Cover



2. Remove the 4 bolts holding the orange shipping bracket in place as shown in the following figure.

Remove Aluminum Shipping Bracket



Attach the Bracket to the Wall

The mounting bracket is a guide for locating where to drill the holes used to mount the Vantage panoramic device to the wall. Carefully placing the mounting bracket on the wall will help to insure correct installation of the Vantage panoramic device.

1. Center the bracket on the studs.
2. Hold the bracket so that it is 121 cm (47 ½ in.) from the floor and mark one of the bracket holes.
3. Drill a 6.3 mm (1/4 in.) hole.
4. Select the 2 wall mount washers and the 2 lag bolts from the hardware kit.
5. Put 1 lag bolt through the washer and bracket mounting hole and loosely tighten the bolt.
6. Lift up the other side of the bracket and level it.
7. Mark the second hole and drill it.
8. Put the second lag bolt through the second washer and second bracket mounting hole and loosely tighten the bolt.
9. Place a level on the top of the bracket and level the bracket.
10. Tighten the bolts to 14-18 ft. lb. maximum.

Test the Bracket



Snap the Vantage Panoramic Device in Place

The Vantage panoramic device and bracket are designed to snap together when correctly aligned and firm pressure is applied. This snap holds the device in place while you complete the installation.

1. Lift up and move the Vantage panoramic device to the mounting wall with the back positioned towards the wall mounted bracket.
2. Line up the Vantage panoramic device with the wall mounted bracket and snap the device into place, making sure the device snaps solidly.

CAUTION! The snap partially secures the Vantage panoramic device. The clamps and floor mount steps must be completed to hold the device in place.

Vantage Panoramic Device and Wall Bracket



Plumb the Vantage Panoramic Device and Attach the Clamps

The Vantage panoramic device and wall bracket must be joined with 2 clamps. This requires a process of alternately screwing the clamps into place and plumbing the device.

1. Select 2 clamps and 2 screws from the mounting hardware kit.

Clamp and Screw



2. Hold 1 clamp in place, aligning it with one of the small holes in the bracket. Insert a screw through the wall bracket hole and the Vantage panoramic device hole. Tighten the screw using a 4 mm hex key. Do not tighten completely.

Clamp Placement



3. Hold a level vertically against the column and move the Vantage panoramic device on the floor until it is plumb.

Column Test



4. Once the column is plumb, repeat the procedure with the second clamp. Do not tighten completely.
5. Do a final level test before completely tightening the clamp screws.

Mount the Vantage Panoramic Device to the Floor

Use the floor base as a template to drill holes in the floor. You do not need to move the Vantage panoramic device for this procedure. Ensure that the device is positioned vertically before drilling holes.

Note

To install the Vantage panoramic device on a free standing base, see Installing the Vantage Panoramic Device on a Free Standing Base in this chapter.

1. Select 2 cement anchors, 2 washers, and 2 nuts from the hardware kit. For wood floors, select 2 lag bolts and 2 washers.
2. Drill through 1 hole in the floor base of the Vantage panoramic device using an 9.5 mm (3/8 in.) masonry bit. For wood floors, use a 6.3 mm (1/4 in.) bit.

Drilling through Floor Base Hole



3. Insert 1 cement anchor through the hole in the plate. Assemble 1 nut and 1 washer on top of the cement anchor and tighten. Ensure that the anchor is fully seated in the hole. For wood floors, assemble 1 lag bolt and 1 washer and insert the lag bolt and washer through the hole in the plate. Screw the lag bolt partially into the hole using a socket wrench.
4. Repeat the process for the second anchor, nut, and washer. For wood floors, repeat the process for the second lag bolt and washer.

Inserting Anchor



5. Tighten the anchors using a 14 mm (9/16 in.) socket wrench. For wood floors, tighten the lag bolts using a 14 mm (9/16 in.) socket wrench (same size as used for cement).

Tightening Anchor



Installing the Vantage Panoramic Device on a Free Standing Base

Preparing to Install the Vantage Panoramic Device on a Free Standing Base

Gather Tools

- Level
- 2 mm hex key
- 4 mm hex key
- 8 mm hex key
- 17 mm socket wrench

Unpack the Hardware Kit

- 2 kinds of bolts: 4 each
- 8 levelers
- 8 leveler plugs

Unpack the Removable Parts Kit

- Chin rest
- 2 wands
- Bite guide

About the Order of Installation

For convenience and access, Progeny recommends the following order of installation described in the following sections:

- Arrange the free standing base halves and levelers
- Attach the Vantage panoramic device to the free standing base
- Remove the shipping brackets
- Attach the power
- Position and mount the Vantage panoramic device to the floor

Arrange the Free Standing Base Halves and Levelers

Prepare the free standing base for attachment to the Vantage panoramic device using the following steps:

1. Remove the free standing base halves from the packaging.
2. Install the levelers in the holes as shown below.
3. Arrange the base halves as shown below, with the levelers in contact with the flooring.

Free Standing Base Halves and Levelers

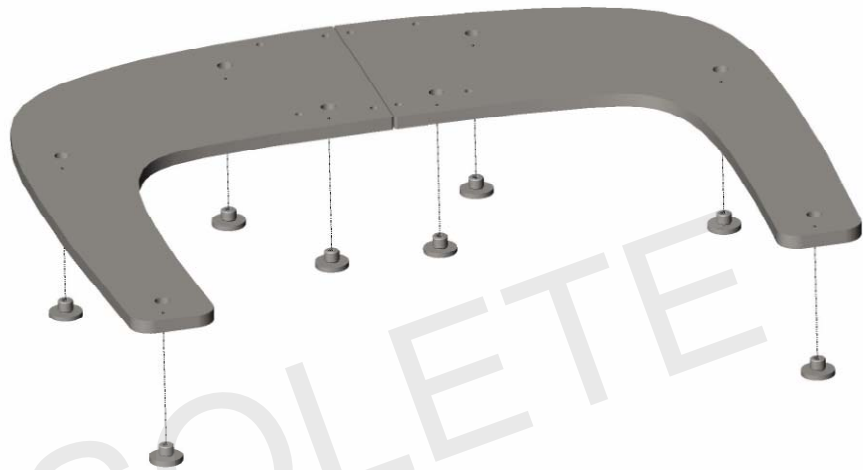

Attach the Vantage Panoramic Device to the Free Standing Base

To attach the free standing base to the Vantage panoramic device, set the Vantage panoramic device on top of the base halves and install the bolts and bracket, using the following steps:

1. Move the Vantage panoramic device over the bases with the overhead pointing the same direction as the legs of the bases.
2. Install the bolts and bracket as shown below, back and front views.

Attaching Vantage Panoramic Device to Free Standing Base: Back View

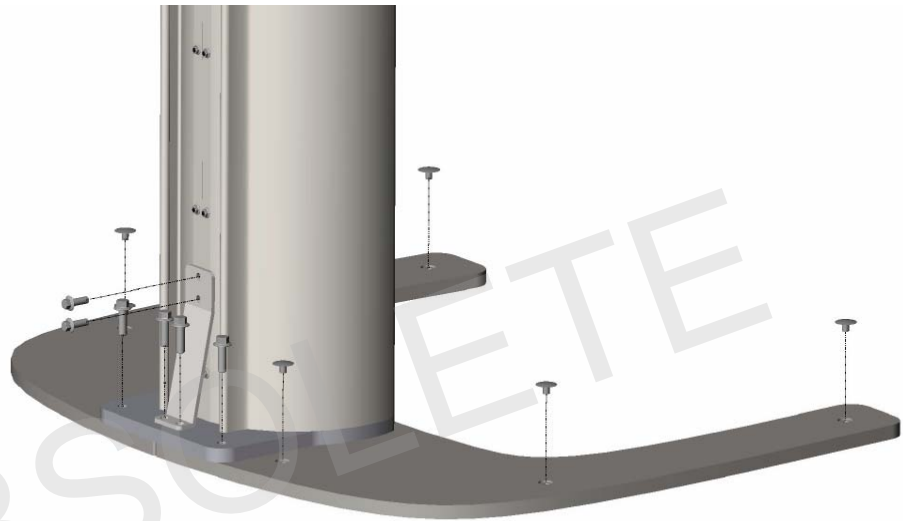

**Attaching Vantage Panoramic Device to Free Standing Base:
Front View**



Remove the Shipping Brackets

Before attaching power, you need to remove the shipping brackets.

1. Remove the overhead top cover and remove the three orange shipping bolts from the overhead pivot area.

Overhead Top Cover



2. Remove the 4 bolts holding the orange shipping bracket in place as shown in the following figure.

Remove Aluminum Shipping Bracket



Position and Mount the Vantage Panoramic Device to the Floor

To attach the Vantage panoramic device to the floor, you need move the unit into position, level the unit, and mount it to the floor using the following steps:

1. Move the Vantage panoramic device on its base into position, and use an 8 mm hex wrench to level the device, ensuring that all levelers are in contact with the flooring.
2. Fix the unit to the floor with the flooring appropriate fasteners through the holes in the center of the levelers.

OBSOLETE

Optional Right Entry Configuration

The Vantage panoramic device is delivered with left entry. To configure with a right entry, remove and rotate the Frankfort Plane Laser Assembly using these steps:

1. To access the Frankfort Plane Laser Assembly, remove the cover from the telescoping section of the column.
2. Disconnect the laser wires.
3. To access the new screw holes where you will install the assembly, remove the small cover on the left side of the mirror assembly (as viewed from the back of the column). Set the small cover aside for later assembly.
4. Remove the 2 screws from the Frankfort Plane Laser Assembly and lift the assembly out. Set the screws aside for later assembly.

Frankfort Plane Laser Assembly

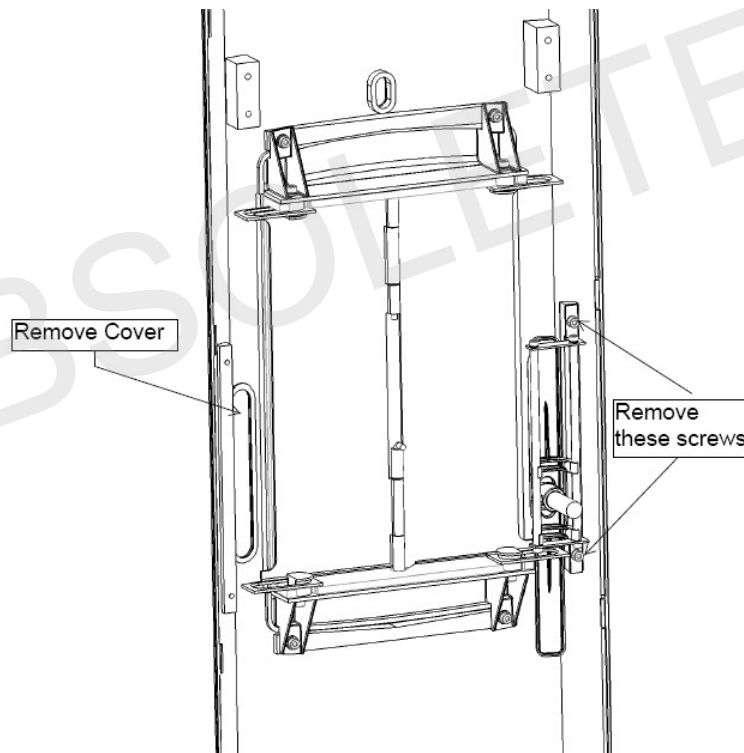

5. Rotate the Frankfort Plane Laser Assembly 180 degrees so that it is upside down.
6. Install the Frankfort Plane Laser Assembly on the left side of the column (as viewed from the back of the column) using the 2 screws.
7. Place the small cover over the screw holes on the right side (as viewed from the back).
8. Reconnect the laser wires.
9. Replace the column cover.

6 Installing the Cables

In this Chapter

- Connecting the Vantage to Your Network
- Installing the Exposure Button

Connecting the Vantage to your network

The Vantage System requires a PC that serves as a workstation to receive images from the Vantage panoramic device. The Vantage must be connected to the same network as the designated workstation in order to connect and receive an image.

1. Attach the PC Ethernet cable to the network connection port on the back of the column and the other end into your network wall jack

Cable Connecting Ports

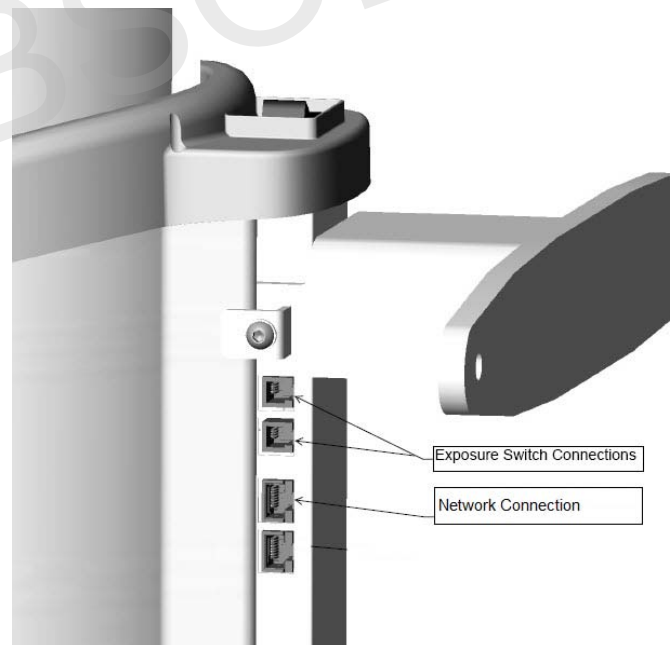

Installing the Exposure Button

The exposure button is used to take the X-rays. The basic configuration is to connect the button to the Vantage panoramic device by means of a coil cord.

Attach the Exposure Button to the Vantage Panoramic Device

To attach the exposure button, insert the coil cord into one of the exposure switch connections on the column shown in the figure above. The exposure switch connections are the top 2 ports.

Mount the Exposure Button

The exposure button comes with double stick tape and a hole for a screw, if desired, for mounting. It can be mounted to the fixed portion of the column or to a wall.

1. To mount the exposure button using the double stick tape, remove the protective backing covering the adhesive mount.
2. Firmly press the mount to the wall or surface as shown in the figure below.

Exposure Button Mounted



7 Starting Up

In this Chapter

- Turning the Vantage System On
- Checking Image Quality
- Progeny Support Information

Turning the Vantage System On

You can turn on the Vantage panoramic X-ray device first or the client software first (see chapter 8 Vantage software client setup). Make sure that all shipping brackets have been removed.

1. To turn on the Vantage panoramic device, press the on/off switch located at the back of the stationary column on top of the box of connections.

Vantage Panoramic Device with On/Off Switch

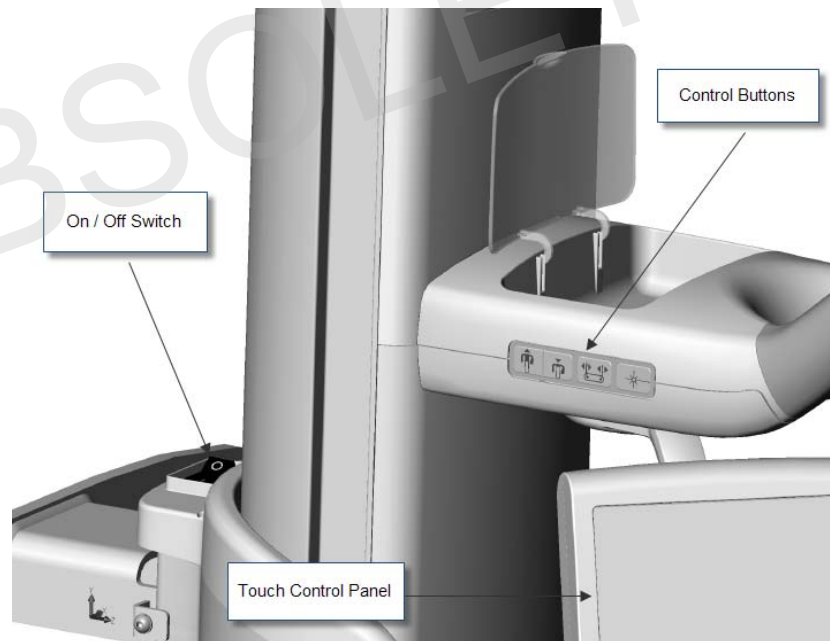

When you turn on the Vantage panoramic device, the touch control panel displays a “Start Up” screen. The Vantage panoramic device goes through a self diagnostic procedure as part of the startup process.

2. If the Client software is not running, launch it and open the image acquisition software.

Checking Image Quality

An image quality phantom is available from Progeny. The phantom simulates the position of average human teeth roots, and markers allow you to check the position of the focal trough. To check for image quality, you need to take an X-ray exposure with the image phantom and then view the image, checking it according to some specific tests.

Install the Image Phantom

The Vantage panoramic device is designed so that the chin rest accessory can easily be switched with the image phantom.

1. To install the image phantom, lift the chin rest from the chin rest hole on the patient positioning table.
2. Set the image phantom in the chin rest hole.

Image Checks

The following checks for image quality are performed on the image after exposing the phantom. In general, each individual line should be sharp where the lines cross the center of the image, and they should blur out above the center line.

1. Verify that the semi-projections $b = c \pm 3$ mm (nominal value with the central vertical line well focused) = 80 mm.



2. Verify that line "a" is vertical ± 3 degrees with respect to the horizontal line "d".

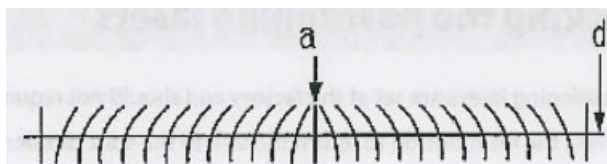

3. Verify that line "d" is horizontal and flat within a band of 6 mm.



4. Verify that the darkened area is centered in respect to the central vertical line "a" with a tolerance of +/- 4 mm.

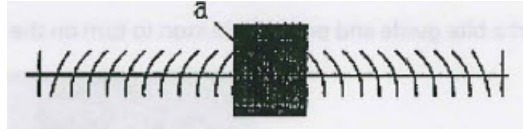

5. Verify that the central vertical line is well focused and adjacent balls are round.

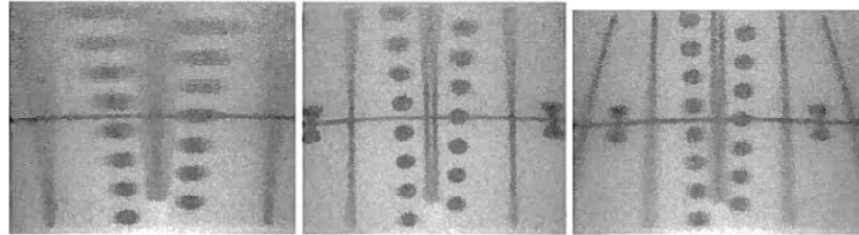

x

✓

x

OBSOLETE

8 Vantage Software Client Setup

In this Chapter

- About
- Installation Procedure
- Connecting to Vantage

About

Vantage acts as a “network appliance” that connects directly to your network. In order to receive x-ray images you must designate at least one workstation on your network to receive them.

Installation Procedure

When installing the software it is assumed that previous versions of the Progeny Device Suite and Progeny Imaging image management software are not present.

NOTE: Proper operation requires any previous version of Progeny Device Suite and Progeny Imaging to be removed (uninstalled) prior to the installation process to begin.

Execute the following steps:

- Insert the USB Flash Drive into an available USB port on your computer and allow the computer to recognize the flash drive.

- The main screen of the installation software is shown on Figure 1. If the software on the USB flash drive does not start automatically, navigate to Windows Explorer™ and select the “Progeny” drive letter. Browse to the content of the flash drive and start “Setup.exe”. This step begins the installation process.

NOTE: The installation software requires Microsoft .NET Framework revision 3.5. This software will be installed if it is not yet present to the operating system. Follow all on screen prompts.

NOTE: If the intended configuration is based on Windows XP, the Service Pack 3 update is required. This update is included on the USB flash drive and can be installed from folder named ‘Utilities’. Another option is to use the Windows update tool provided by Microsoft.

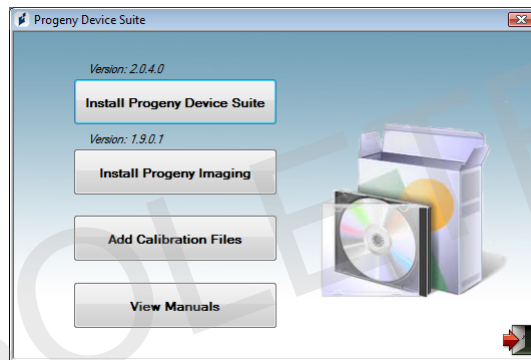

Figure 1: Main screen of the Installation software

- Start the installation process by clicking on 'Install Progeny Device Suite' button (Figure 2).

NOTE: The installed software requires multiple software components that may already be available in your system. These components will be installed if they are not yet present. Follow all on screen prompts.

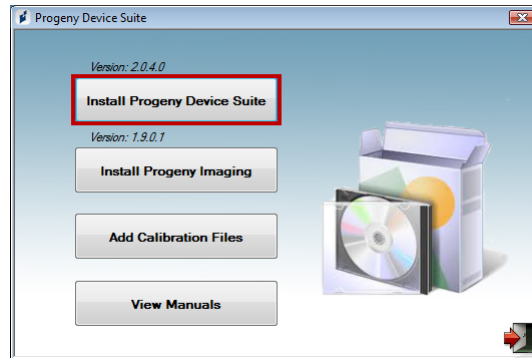

Figure 2: Starting the Progeny Device Suite installation

- The screen on Figure 3 will be displayed. Choose Vantage Pan and all other device families that have to be supported by the Imaging Software.

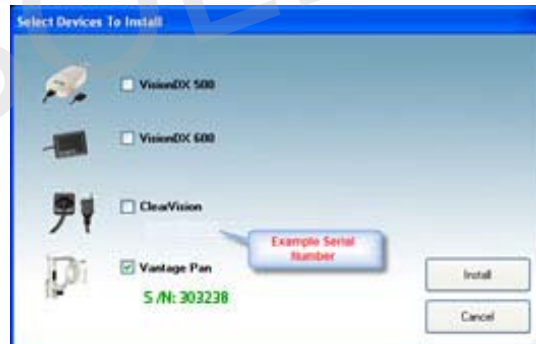

Figure 3: Selecting the device families to be installed

- A green check mark next to the 'Install Progeny Device Suite' button will appear when Progeny Device Suite installation is completed. Continue by installing Progeny Imaging software by clicking on 'Install Progeny Imaging' button (Figure 4) and follow the prompts on the screen to perform the installation.

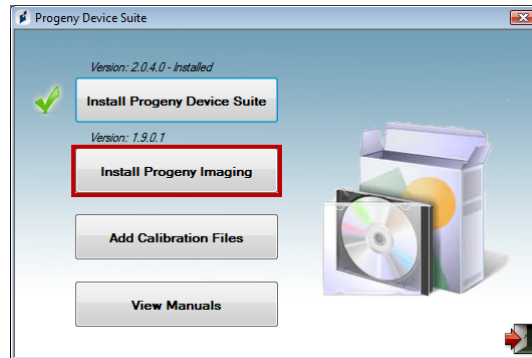

Figure 4: Starting the Progeny Imaging installation

- Green check marks next to each of the 'Install Progeny Device Suite' and 'Install Progeny Device Suite' buttons will appear when both the Progeny Device Suite and Progeny Imaging are installed (Figure 5).

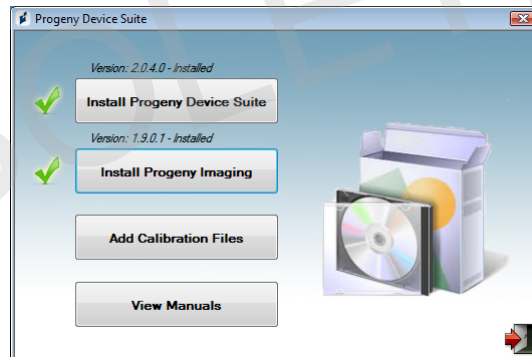

Figure 5: Progeny Device Suite and Progeny Imaging are installed

Connecting to Vantage

Connecting your computer to the Vantage system can be setup either through Progeny Imaging image management software or through Progeny's TWAIN interface.

- If you are using Vantage Pan from a 3rd party application you need to open Progeny's TWAIN interface to connect to the Vantage system. Some image management programs also support Vantage integration. See your image management software support for more information on how to access the Vantage.
- Select "Vantage Pan" in the device drop down if it has not already been selected



- To access device configuration:
 - **TWAIN:** Click the device configuration icon



- **Progeny Imaging:** In the top menu browse to Tools > Devices > Device Configuration
- If you have already connected to a device it will be listed in the Server Connection section. Click the "Connect" button.

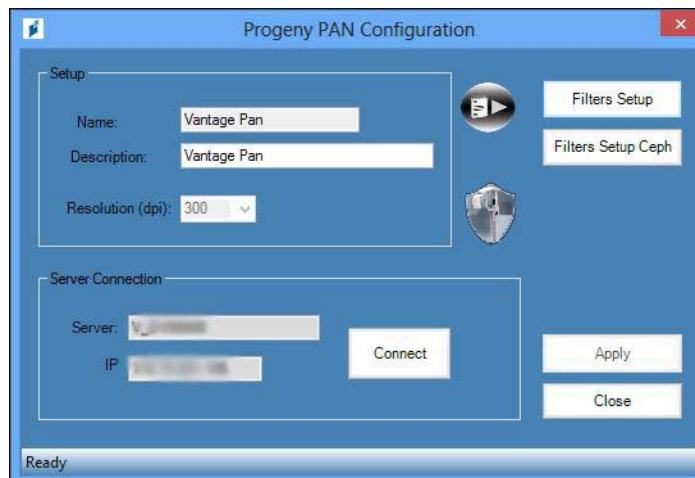

- The “Select Pan Server” window will automatically discover the Vantages in your network. Highlight the vantage you want to connect to and click the “Select” button.

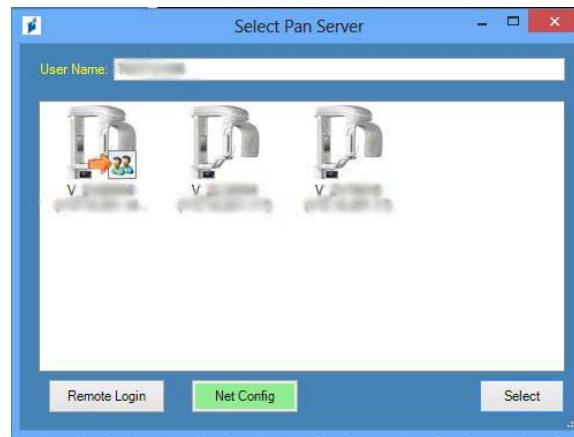

- **Optional User Name:** The User Name field is what's used to identify your Vantage Client in the network. The default is your computer's name.
- **Optional Network Adapters:** Progeny Device Suite will automatically detect the most suitable network adapter on your computer for connecting to the Vantage. If your Vantage is not automatically discovered click the “Net Config” button to select a specific network adapter.

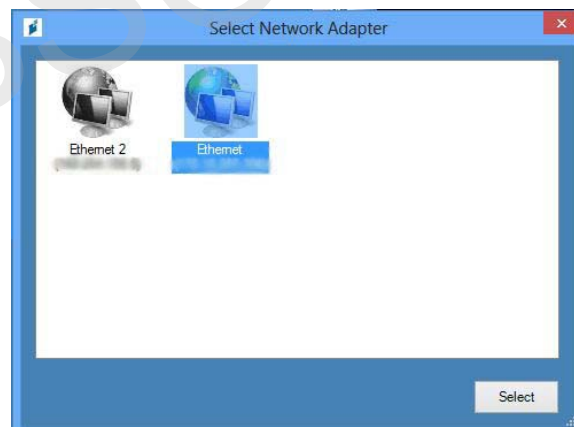

- Once returned to Device Configuration screen the Vantage you selected will be visible in the “Server Connection” section. Click the “Close” button to complete the connection.

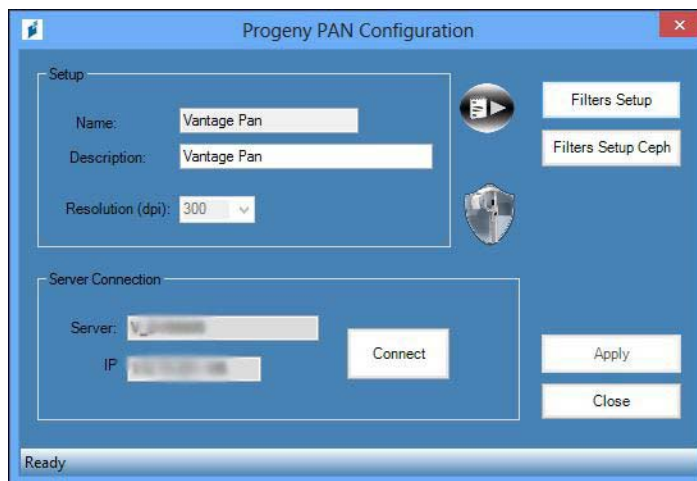

- Once you close Device Configuration and you are back at the client application the light for “Vantage Pan” should now turn green.



- At this point you can take images with the Vantage Panoramic and they will be delivered to the client. You can repeat these steps at any time to connect to another Vantage panoramic device.

Progeny Support Information

For Technical Support, contact:

MIDMARK CORPORATION
675 Heathrow Drive
Lincolnshire, Illinois 60069 U.S.A.
Phone: 888-924-3800 (Press 3) (U.S. and Canada)
+1 847-415-9800 (Press 3) (International)
Fax: 847-415-9810
techsupport@progenydental.com

Hours: 8:00 a.m. – 5:00 p.m. CT